

# SERVO TYP 7

Art.-Nr.

396 111  
396 126

700  
1800  
350  
[mm]

1/7  
v0  
24-2024

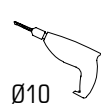
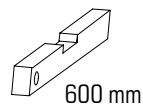
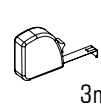
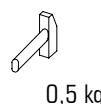
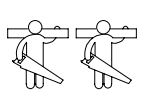

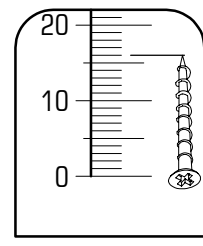
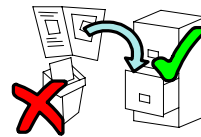
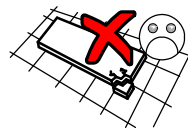
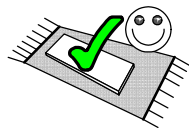
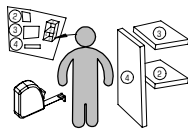
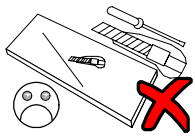
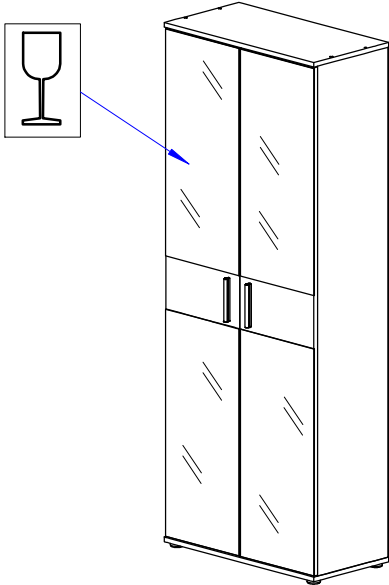
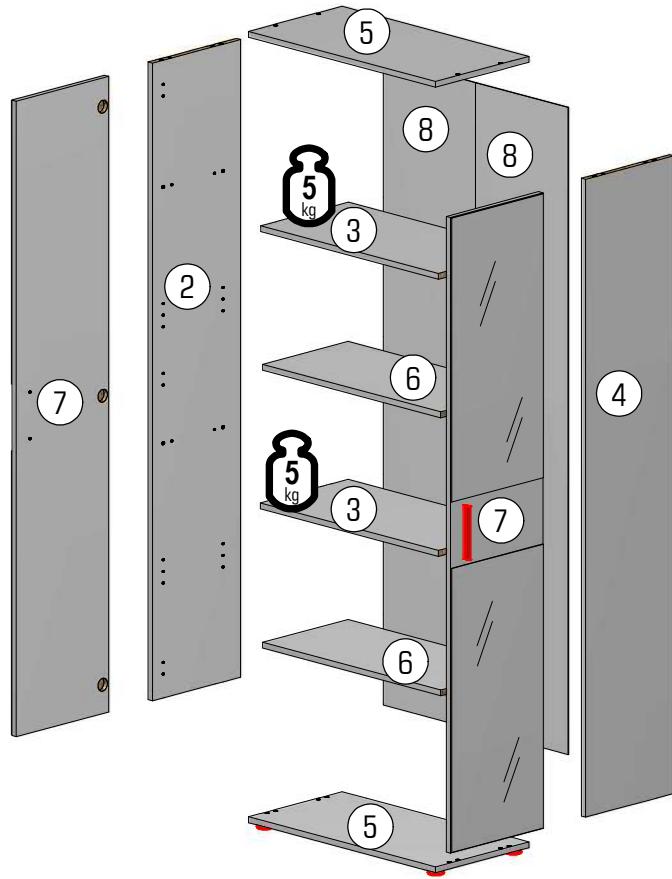

ID	ID	Image	Dimensions	Quantity	Ratio
21401	②		1752*330*16	1x	1/2
21402	③		666*329*16	2x	2/2
21403	④		1752*330*16	1x	1/2
21404	⑤		700*350*16	2x	2/2
21405	⑥		666*320*16	2x	2/2
21406	⑦		1746*346*16	2x	1/2
21407	⑧		1778*346*3	2x	1/2

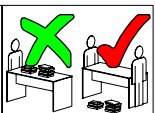
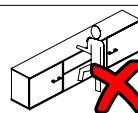
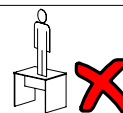
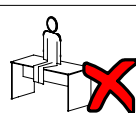
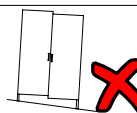
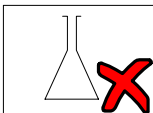

22250,00		Ø4x25	22256,00		Ø5,0x70	22280,00		Ø4x30	22243,00		Ø3,5x15	22244,01		Ø3,5x16	22800,01		4
A	4x	B	1x	C	4x	D	12x	E	2x	F	8x	G	1x				
21102,00		Ø1,6x20	22300,00		Ø7x50	24101,00		Ø10	27000,00		Ø8x30	35101,01		Ø5 x8	30080,00		Ø44x15
H	75x	J	8x	K	1x	L	16x	M	8x	N	4x	P	1x				
32030,00		L=150	70013,01		Ø15x13	70021,01			36002,07			36002,07					
Q	2x	U	8x	V	8x	X	6x	Y	6x	Z	4x						



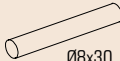

# 2/7 SERVO TYP 7

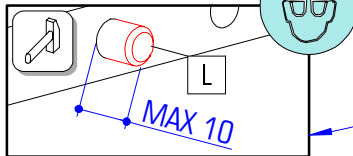
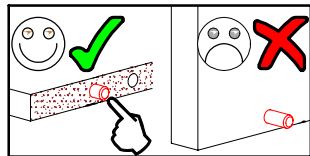
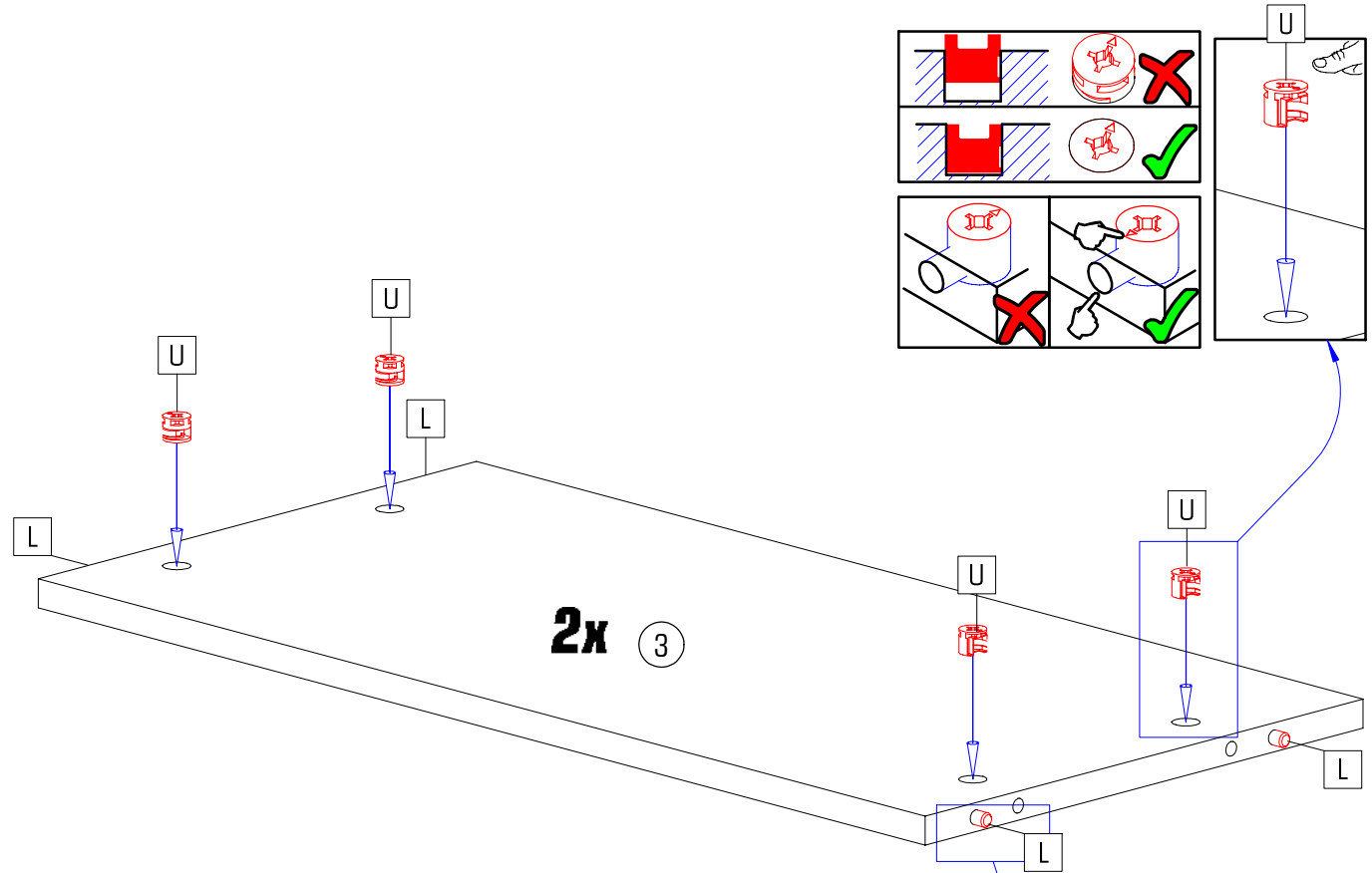
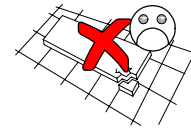
	Ø8x30		Ø15x13
L	8x	U	8x

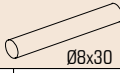

# SERVO TYP 7 3/7

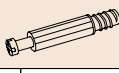
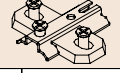
			
L 8x	M 8x	V 8x	Y 6x

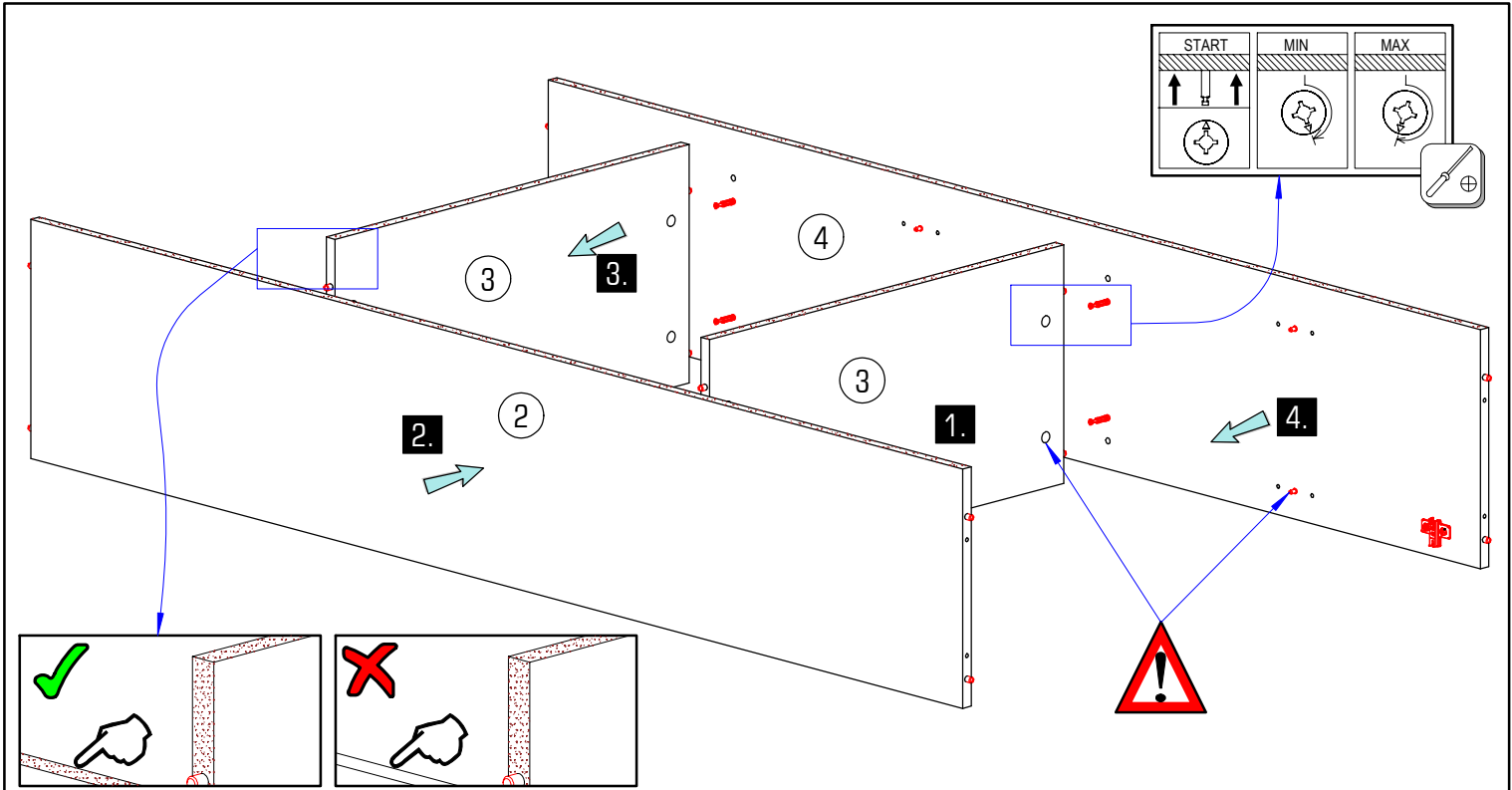
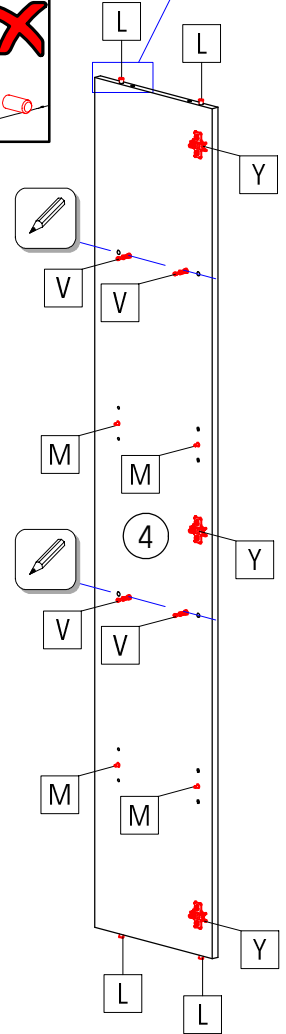
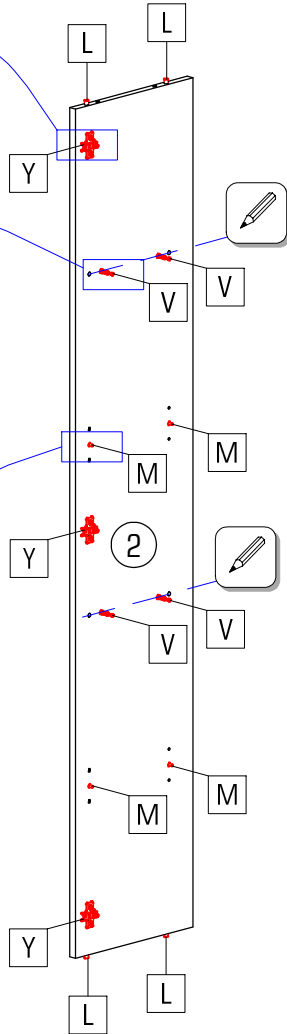
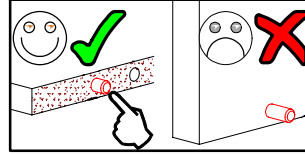
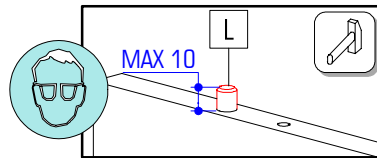
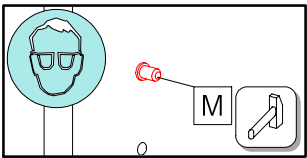
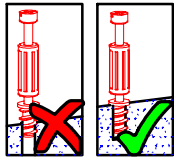
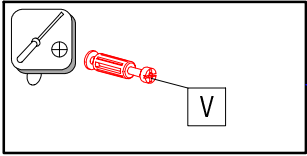
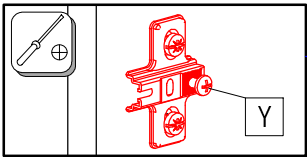



# SERVO TYP 7 5/7

B 1x	E 2x	F 8x	K 1x	P 1x

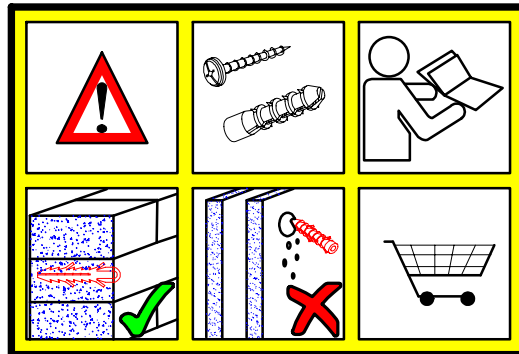
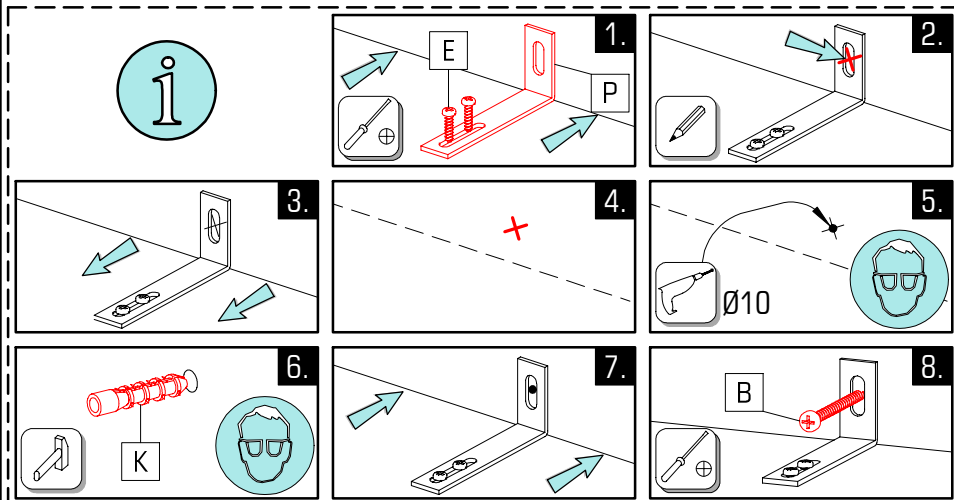

**PL Uwaga!** Ścianę należy sprawdzić przed montażem. Dołączone uniwersalne kołki rozporowe są odpowiednie tylko do stosowania w mocnych murach, takich jak beton lub cegła. Nie rób za pomocą kołków ozporowych murowanych, takich jak pustak, lekka kostka, powierzchnie takie jak płyty gipsowo-kartonowe lub inne systemy ram. Jeśli dotyczy, muszą to być określone kołki rozporowe być użytych! Są one dostępne w specjalistycznym sklepie niezgodność, producent / sprzedawca lub importer nie ponoszą odpowiedzialność.

**DE Achtung!** Die Wandbeschaffenheit ist vor der Montage unbedingt zu prüfen. Die beigelegten Universaldübel sind ausschließlich nur zur Verwendung für festes Mauerwerk wie Beton/Ziegel. Die Mauerdübel dürfen nicht bei Mauerwerk wie Hohlraumziegel, Leichtbausteinen, Gipskartonplatte oder anderer Rahmenbauweise verwendet werden. Bei diesen Mauerwerken sind gegebenenfalls Spezialdübel zu verwenden! Diese sind in einem Fachgeschäft erhältlich. Bei Nichterhaltung wird seitens Produzenten/Händler und Importeur keine Haftung übernommen.

**EN Caution!** The wall must be examined before assembly. The included universal wall plugs are only suitable for using in firm masonry such as concrete block or brick. Do not using the wall plugs masonry such as hollow brick, lightweight block, surfaces such as gypsum plasterboard or other framing systems. If applicable, particular wall plugs must be used! These are available at a specialised store (hardware store). In case of non-compliance, the manufacturer/retailer or importer do not assume liability.

**RO Prudență!** Zidul trebuie examinat înainte de asamblare. Prizele de perete sunt adecvate numai pentru utilizarea în zidărie fermă, cum ar fi betonul bloc sau cărămidă. Nu folosiți zidăria zidurilor de perete, cum ar fi caramida goală, blocul ușor, suprafețe cum ar fi gips-carton sau altă încadrare sisteme. Dacă este cazul, trebuie folosite anumite prize de perete! Acestea sunt disponibile la un magazin specializat (magazin de hardware). În caz de nerespectare, producătorul / vânzătorul sau amănuntul sau importatorul nu își asumă răspunderea.

**HR Pažnja!** Prije montaže obvezno provjerite svojstvo zida. Priložene univerzalne tiplje namijenjene su isključivo za masivne zidove od betona/opeke. Tiplje za masivne zidove ne smiju se koristiti za zidove kao npr šupljina opeka laki sastavni elementi, gips-kartonske ploče ili drugi modularni načini gradnje. Za te zidove potrebne su eventualno posebne tiplje! Iste su dostupne u specijaliziranim trgovinama građevinskim materijalom. U slučaju nepridržavanja prethodno navedenih napomena, proizvođač/trgovac i uvoznik ne preuzimaju odgovornost!

**CZ Upozornění!** Před montáží je nutné zkontrolovat stav stěny. Přiložené univerzální hmoždinky jsou určeny pouze k použití pro pevné zdivo jako beton/cihly. Hmoždinky do zdi se nesmí používat u dutinová cihla, zdiva jako pórovitý stavební kámen, sádrokartonová deska nebo jiný měkký materiál. U těchto zdív jsou nutné použít speciální hmoždinky! Jsou k dostání v speciálních prodejnách se stavebním materiálem. Při nedodržení těchto pokynů výrobce/prodejce a dovozce neručí za způsobené škody.

**SI Pozor!** Pred montažo preverite stanje stene. Priloženi univerzalni mozniki so izključno samo za uporabo na čvrstem zidovju, kot sta beton in opeka. Stenski mozniki se ne smejo uporabljati pri zidovju kot so votlino opeke, zidaki za lahko gradnje, mavčne plošče ali druge okvirne gradnje. Pri teh zidovjih morate v danih primerih uporabljati posebne moznike. Ti so na voljo v specializiranih trgovinah (trgovinah z gradbenim materialom) Pri upoštevanju se s strani proizvajalca/trgovca in uvoznika ne prevzame jamstvo.

**HU Vigyázat!** Szerelés előtt a falfelületek feltétlenül vizsgálja meg. A mellékelt univerzális tiplik kizárólag stabil falazathoz használatos mint például beton/tégla. A fali tiplik nem használatos könnyű építőkövekhez, üreg tégla, gipszkarton lapokhoz vagy más favázás építményekhez. Ezekhez a falfelületekhez csak speciális tiplik használhatóak, melyek szaküzletekben (barkácsáruházakban) beszerezhetőek. Fentiek figyelmen kívül hagyása esetén a gyártó/kereskedő vagy forgalmazó nem vállal felelősséget.

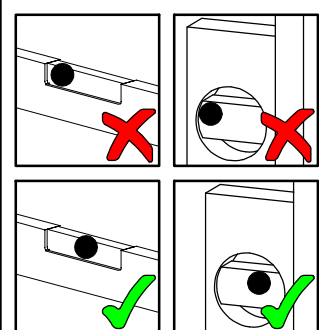
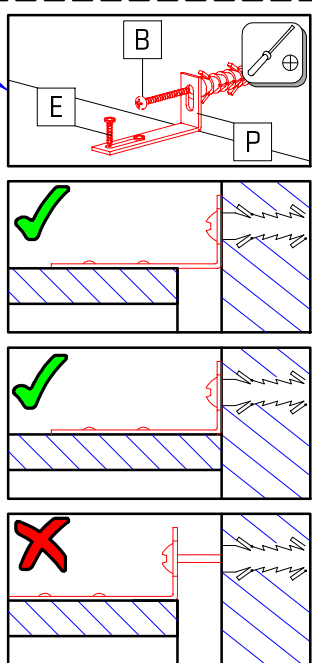
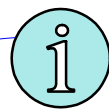
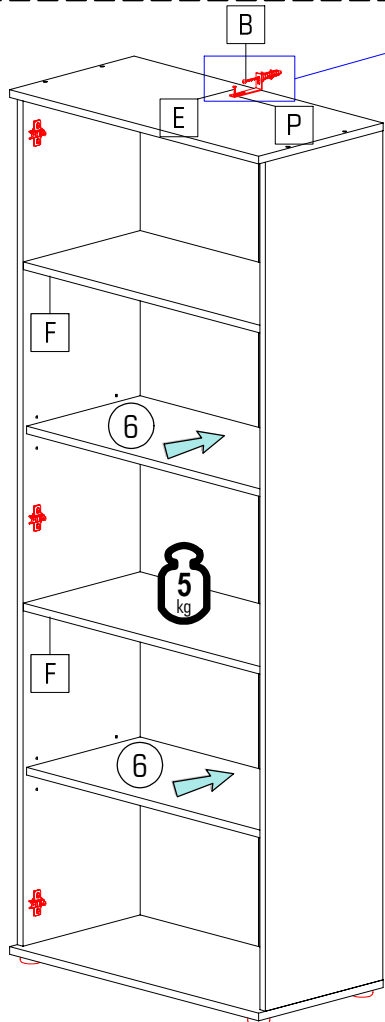

**SK Upozornenie!** Pevnosť steny sa musí pred montážou bezpodmienečne skontrolovať. Priložené univerzálne hmoždenky používajte jedine pre pevné murivo ako je betón/tehla. Hmoždenky sa nesmú používať v prípade ľahkého stavebného muriva, dutá tehla, sádrokartónová doska, alebo iných konštrukcií rámu. U týchto stien je nutné použiť špeciálne hmoždenky! Tieto je možné dostať v špeciálnych predajniach so stavebným materiálom. Pri nedodržaní pokynov nepreberajú výrobca/predajca a dodávateľa zodpovednosť za vzniknuté škody.





<b>SK</b>	VÝSTRAHA
<b>CZ</b>	VAROVÁNÍ
<b>HR</b>	UPOZORENIE
<b>DE</b>	WARNUNG
<b>HU</b>	FIGYELEM
<b>PL</b>	OSTRZEŻENIE
<b>RO</b>	AVERTIZARE
<b>EN</b>	WARNING
<b>SI</b>	OPOZORILO

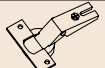

# 6/7 SERVO TYP 7

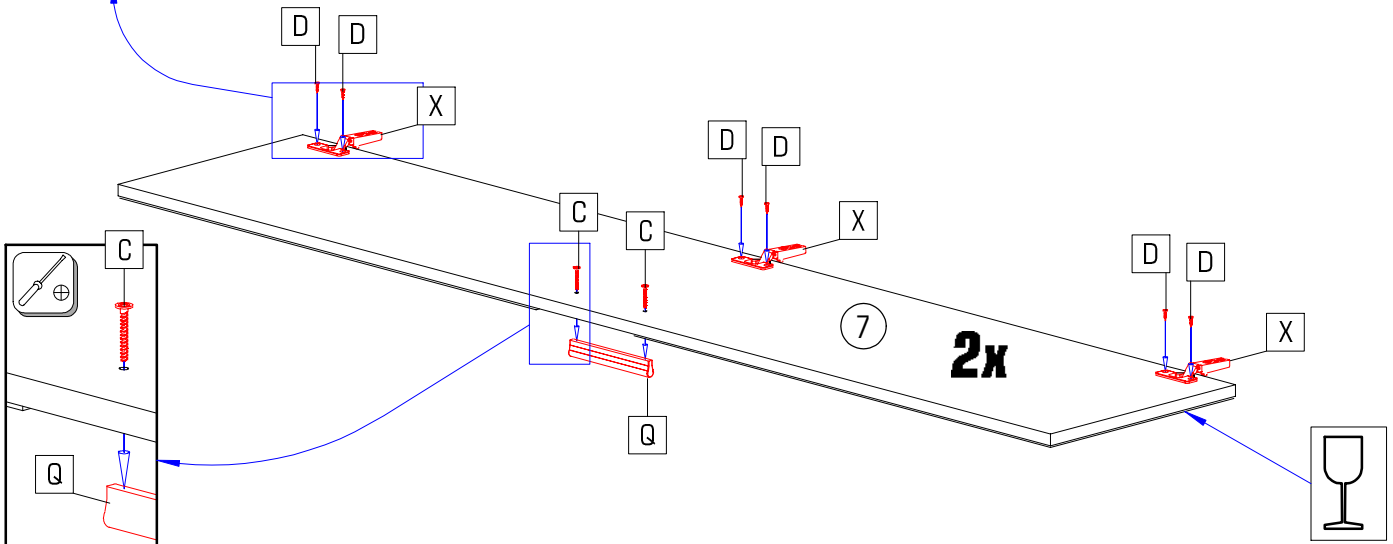
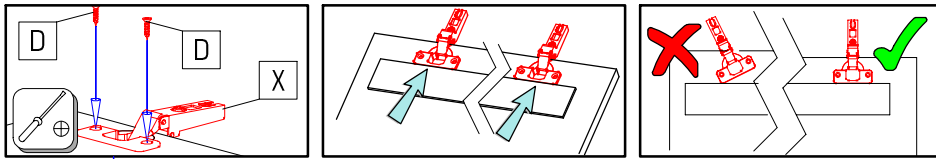
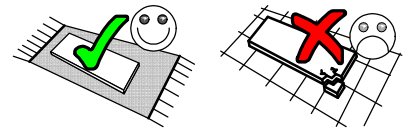
			
Ø4x30	Ø3,5x15	L=150	
C 4x	D 12x	Q 2x	X 6x



Z 4x

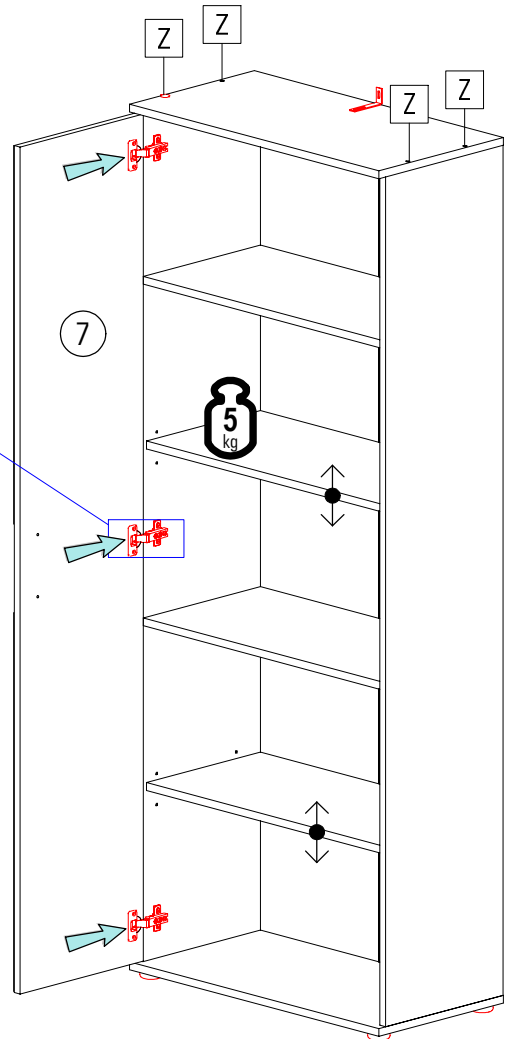
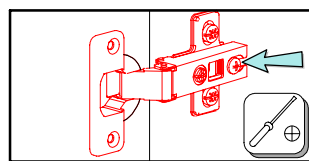

**i** ± 32 [mm]

